

# Shearbolt terminals

---

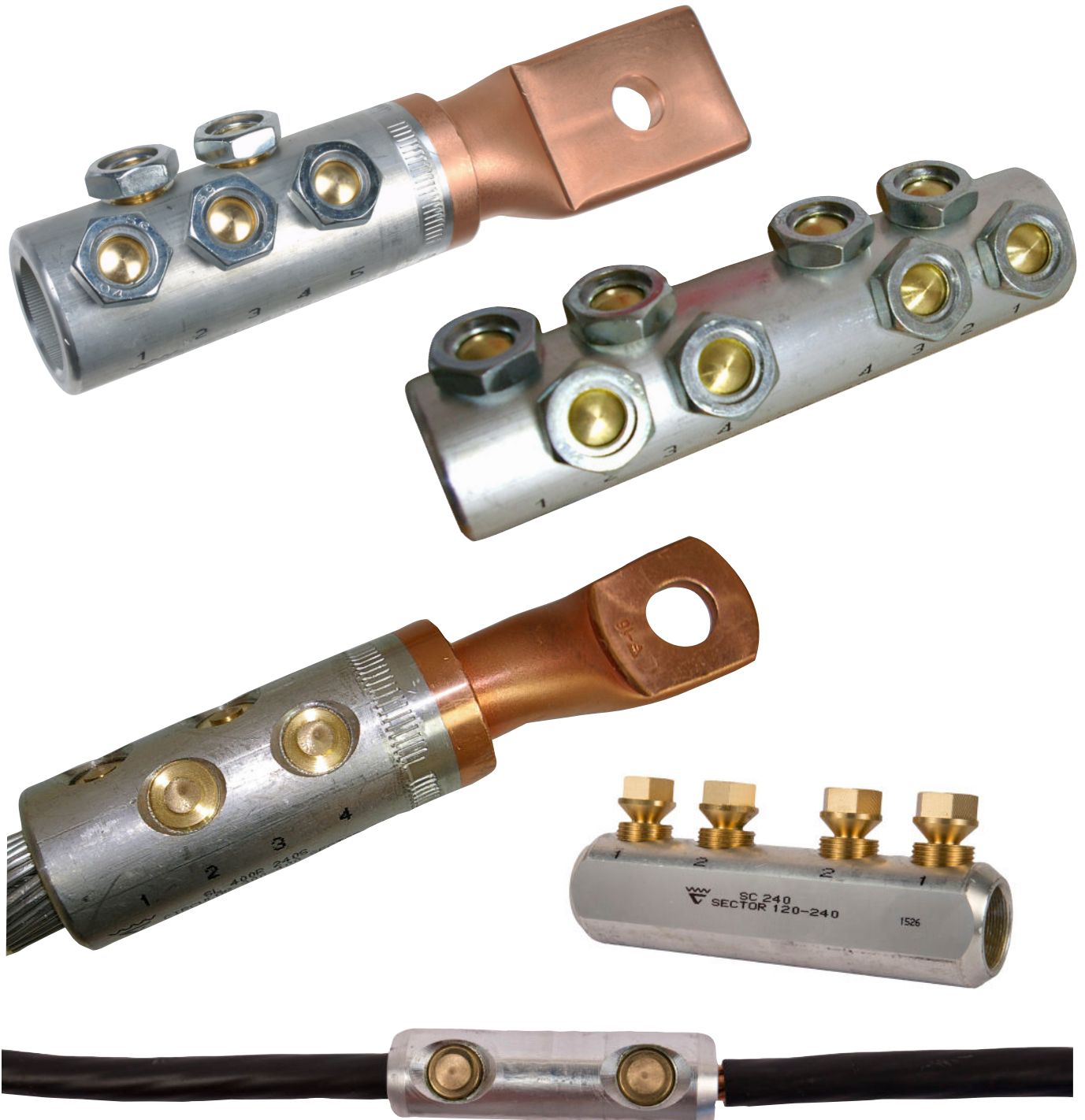

# Shearbolt terminals for low and medium voltage

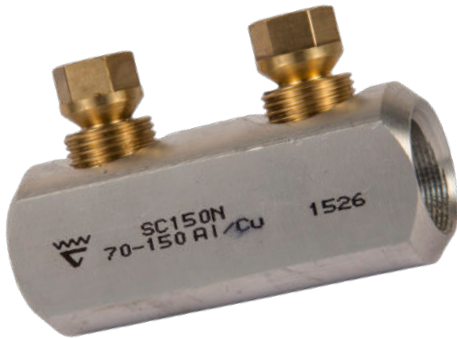

Using shearbolt connectors, assembly can be performed easily without heavy special tools and they can handle several cable sizes in a single through connector/terminal. Shearbolt connectors provide the user with a flexible solution.

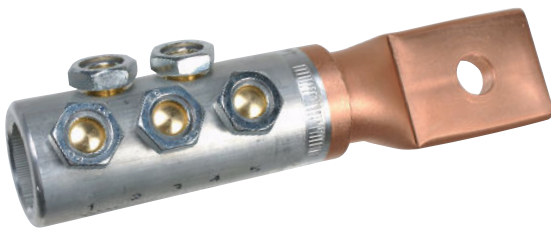

Shearbolt connectors are made of an aluminium alloy that allows splicing of both copper and aluminium cable without the risk of galvanic corrosion. Shearbolt terminals are supplied with filler washers that allow the use of two different bolt sizes, in order to reduce the number of terminal variants.

Elpress shearbolt terminals for low and medium voltage are available as through connectors and cable terminals for:

- stranded and solid Al and Cu cables
- round cross section cables 10-630 mm<sup>2</sup>
- sector cross section cables 10-240 mm<sup>2</sup>
- low and medium voltage up to 36 kV

## Properties

- meet the requirements of IEC 61238-1:2003
- shearbolt terminal with copper palm
  - provides better contact with Cu bus bar than Al palm
  - can be attached to Al bus bar without corrosion problems (provided it is an alloyed Al bus bar that can withstand the application environment)
- optimised sleeve that provides good pre-tension and long service life
- partition in the connector sleeves to prevent oil leakage
- the shearbolt terminals are available with pre-threaded screws and with reversible screws
- screws made of brass provide low friction and strong threads
- all brass screws shear when tightened to the correct torque

## Tool

Tool for assembly can be a socket spanner or a nut driver with torque force >100 Nm. We recommend that the fitter uses a counter-hold tool to secure the cable terminal or the connector when tightening the torque screws.



ISL2201,  
holding tool



**ELPRESS**<sup>®</sup>

# Shearbolt terminals 1-36 kV

## Shearbolt terminals with pre-threaded screws 10-630 mm<sup>2</sup>

### Properties

- suitable for both Al and Cu, Class 1 and Class 2 cable
- pre-threaded shear-off screws for easy handling
- the terminals are of the bimetallic type for best functionality

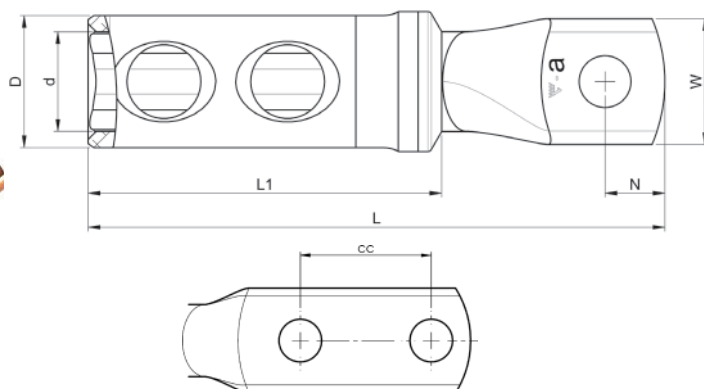

Cable types, mm <sup>2</sup>		kV	Shearbolt terminal	Screened conductor	Screened conductor (filler piece purchased separately)	L mm	W mm	L1 mm	ø D mm	ø d mm	N mm	cc mm	Screw
round	section												
10-50	10-50	1	SL50N-10-12	10-35		80	24.5	41	23	16	12.5		M10, M12*
35-95	35-95	1	SL95N-10-12	57-95	16-50 (SC95N/PEN)	98	27.3	52.5	17	10.7	12.5		M10, M12*
120-240	120-240	1	SL240N-10-12		29-146 (SC240N/PEN)	144.5	31.5	89	33.0	24.5	15		M10, M12*
185-240		1-36	SL240R-12-16			134	30	79	33.5	20	15		M12, M16*
185-240		1-36	SL240R-12X2-40			174	31.5	79	33.5	20.0	15	40	M12
300-400		1-36	SL400R-12X2-40			210	42	103	41.5	25.8	15	40	M12
630		1-36	SL630B-12X2-40			218	55	115	49.0	33.0	17	40	M12

\* reducer washer included

## Shearbolt terminals with reversible screws 10-630 mm<sup>2</sup>

### Properties

- suitable for both Al and Cu, Class 1 and Class 2 cable
- reversible shear-off screws
- the terminals are of bimetallic type for best functionality

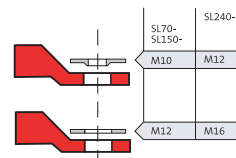

### Reducer washers

The reducer washer is included with shearbolt terminals with a flat hole. The reducer washer is used to reduce the bolt dimension by one size.

Cable types, mm <sup>2</sup>		kV	Shearbolt terminal	Screened conductor	L mm	W mm	L1 mm	ø D mm	ø d mm	N mm	cc mm	Screw
round	section											
10-70	25-70	1-36	SL70R70S-10-12	10-57	97	25.5	59	21	10.7	12.5		M10, M12*
95-150	95	1-36	SL150R95S-10-12	70-95	116	30.5	75.5	27	16	12.5		M10, M12*
95-150	95	1-36	SL150R95S-12X2-40	70-95	172	30.5	75.5	27	16	15	40	M12
185-240	120-185	1-36	SL240R185S-12-16		134	31.5	79	33.5	20	15		M12, M16*
300-400	240	1-36	SL400R240S-16		182	41.5	103	41.5	25.8	21		M16
300-400	240	1-36	SL400R240S-20		182	41.5	103	41.5	25.8	21		M20
300-400	240	1-36	SL400R240S-00		187	41.5	103	41.5	25.8	-		-
500-630	-	1-36	SL500B-630B-12X2-40		218	55	115	49	33	12	40	M12
500-630	-	1-36	SL630R-1		243	55	129	49	33	-		-
500-630	-	1-36	SL630R-16		241.5	55	129	49	33	30		M16
500-630	-	1-36	SL630R-14		243	55	129	49	33	30		M14
500-630	-	1-36	SL630R-12X2-40		243	55	129	49	33	15	40	M12

\* reducer washer included



**ELPRESS**

# Shearbolt through connectors 1-36 kV

## Shearbolt through connectors with pre-threaded screws 10 - 240 mm<sup>2</sup>

### Properties

- suitable for both Al and Cu, Class 1 and Class 2 cable
- partition to prevent oil leakage
- pre-threaded shear-off screws for easy handling

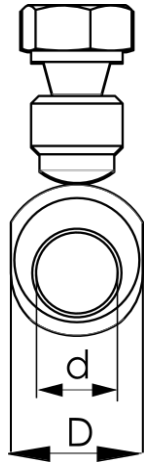
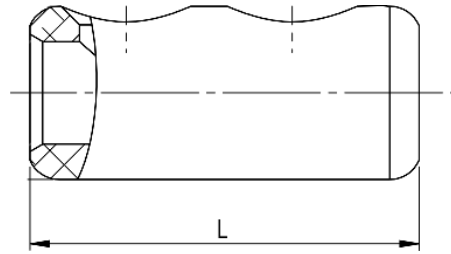

Cable types, mm <sup>2</sup>		kV	Through connector	Screened conductor	Screened conductor (filler piece purchased separately)	L mm	ø D mm	ø d mm
round	section							
10-50	16-50	1	SC50R50S	10-35		62	17.3	10.7
35-95	50-95	1	SC95N	57-95	16-50 (SC95N/PEN)	69	23.0	16.0
70-150	70-150	1	SC150N	120-146	21-95 (SC150N/PEN)	80	23.0	19.5
95-240	120-240	1	SC240N		29-146 (SC240N/PEN)	144	33.1	25.0

## Shearbolt through connectors with reversible screws 10 - 630 mm<sup>2</sup>

### Properties

- suitable for both Al and Cu, Class 1 and Class 2 cable
- partition to prevent oil leakage
- reversible shear-off screws

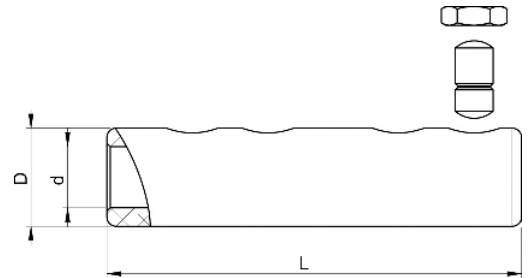

Cable types, mm <sup>2</sup>		kV	Through connector	Screened conductor	Screened conductor (filler piece purchased separately)	L mm	ø D mm	ø d mm
round	section							
50-95	50-95	1-36	SC95R95S	70-95	16-57 (SC95N/PEN)	114	27.0	16.0
95-150	95	1-36	SC150R95S	70-95		114	27.0	16.0
185-240	120-185	1-36	SC240R185S			134	33.5	20.0
300-400	240	1-36	SC400R240S			175	41.5	25.8
500-630	-	1-36	SC630R			210	49.0	33.0

## PEN - filler piece for shearbolt connectors

Filler piece that works perfectly when connecting screened conductors.

Filler piece
SC95N/PEN
SC150N/PEN
SC240/PEN

